

Reduction of dioxygen in neutral solution at polypyrrole electrode

S. BIALLOZOR, T. ZALEWSKA, A. LISOWSKA-OLEKSIK

Department of Chemical Technology, Technical University of Gdańsk, 80-952 Gdańsk, Narutowicza 11/12, Poland

Received 24 April 1995; revised 15 February 1996

Oxygen electroreduction has been investigated in 0.1 M Na₂SO₄ aqueous solution on an electrode covered by a polypyrrole (PPy) layer. The dependence of the reduction rate on the thickness of the PPy film has been established. The electrocatalytic properties of PPy in the studied electrode process have been confirmed. It was concluded that the nickel electrode covered with a PPy layer can be employed for water deoxygenation.

List of symbols

j	current density (A m ⁻²)		a measure of a rotation of the impedance spectrum in the complex plane given as 90° (1 - n)
E	electrode potential (V)		
R_b	represents an electrolyte resistance		
R_1, R_2 and R_1^*	resistance related to the polymer resistance and the red-ox reaction resistance of PPy ⁺ /PPy ^o (Ω cm ²)	<i>Descriptions</i>	
CPE ₁ , CPE ₂ and CPE ₁ [*]	constant phase elements	a	anodic
Q_1, Q_2, Q_1^*	constants representative for CPE	c	cathodic
n	parameter between zero and unity,	1,2	indicates values for Pt/1 μm PPy electrode
		1*	indicates values for Pt/3 μm PPy electrode

1. Introduction

Electron conducting polymers (ECP), especially polypyrrole (PPy), are recognized as promising electrode materials. One of the many possible uses of polypyrrole is its application for the electroreduction of oxygen [1–3]. Due to the possibility of using ECP as an electrode material in hydrogen–oxygen fuel cells oxygen reduction on PPy was investigated primarily in 0.5 M H₂SO₄. The oxygen electroreduction process can also be used for the removal of oxygen from water to decrease its corrosivity [4, 5]. The authors have proposed the application of copper as the cathodic material. However, our efforts to conduct water deoxidation in the described conditions have shown that oxygen reduction proceeds at small rates.

In this work the possibility of using PPy as the cathodic material for electroreduction of oxygen in solutions of pH close to 7 was checked. Results for electroreduction of oxygen in 0.1 M Na₂SO₄ on polypyrrole covered electrodes are presented.

2. Experimental details

Investigations of oxygen electroreduction proceeding on polypyrrole modified electrodes were carried out in 0.1 M solution of Na₂SO₄ 99.99% purity (POCh, Poland) in triply distilled water. The solution was kept either in contact with air at a pressure of 1 atm

or deaerated by 2 h purging with argon. All experiments were conducted at 20 ± 1 °C.

The process was investigated using cyclic voltammetry (CV), chronoamperometry (CA) and impedance spectroscopy (IS). An electrolysis at constant potential was also carried out. Pt, Ni (97%), glassy carbon (GC) and steel (ST-3) were used as working electrodes. The nominal surface areas of the working electrodes in the CV, CA and IS experiments was 0.008 cm². A platinum sheet of surface area approximately 100 times larger than the area of the working electrode was used as the counter electrode. In the electrolysis electrodes of surface area 2.4 cm² were used. A Hg/Hg₂SO₄/0.1 M H₂SO₄ electrode was used as reference, the potential of which was recalculated in relation to the NHE neglecting the liquid junction potential. All measured values of potential are given relative to NHE. Preparation of the platinum surface included polishing with 0.05 μm Al₂O₃ powder, followed by rinsing with distilled water, then immersing into concentrated H₂SO₄ and finally rinsing with triply distilled water. The glassy carbon electrodes were cleaned mechanically by polishing with 0.05 μm alumina and rinsed with triply distilled water in an ultrasonic bath. The steel and nickel electrodes were cleaned mechanically using emery paper (grade 1000), degreased and washed with distilled water. The polypyrrole films were prepared electrochemically under anodic polarization ($j_a = 0.4 \text{ mA cm}^{-2}$)

in oxygen-free solution containing 0.14 M pyrrole and 0.2 M NaClO₄ in methanol [6]. The film thickness was controlled by the amount of charge passed [3]. A one compartment cell was used for the CV, CA and IS. For electrolysis a two compartment cell was used in order to avoid direct contact between the anolyte and the catholyte and the electrical contact was provided by a salt bridge. The experiments were performed in air saturated solutions. In this case catholytes were continuously purged with air during the experiment. The pH change of the catholyte and the amount of H₂O₂ produced by oxygen reduction were also controlled. A high resistance pH meter equipped with a simple glass electrode was used for pH measurements. The concentration of H₂O₂ in the catholyte can be determined spectrophotometrically in the visible range using Fe(CN)₆³⁻ in alkaline solution [7]. However, we found a potentiometric measurement of the red-ox potential of the Pt/Fe(CN)₆³⁻/Fe(CN)₆⁴⁻ electrode was more reliable in the case of the low concentrations of H₂O₂.

3. Results and discussion

3.1. Impedance spectroscopy measurements

The IS measurements were conducted to characterize polypyrrole covered electrodes at open circuit potential. We were interested in the total impedance of the electrode covered with PPy. Figure 1 represents complex plane impedance plots obtained on the Pt/1 μm PPy in a deaerated (DAR) and a nondeaerated (NAR) 0.1 M Na₂SO₄ solution at an open circuit potential of 0.445 V vs NHE. An a.c. signal of 10 mV amplitude in the frequency range from 60 kHz to 1 Hz was applied in all cases.

Non-linear least-squares analysis (NLLS) was performed to fit the impedance of the equivalent circuit (EQC) to the data. Figure 2 represents the equivalent circuits for the Pt/1 μm PPy (a) and the Pt/3 μm PPy (b). The EQC for Pt/1 μm PPy consisted of R_b, R₁,

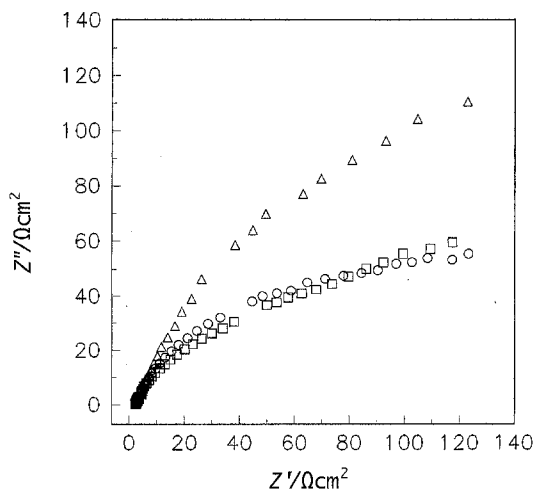

Fig. 1. Complex plane impedance plots obtained for the Pt/3 μm PPy in the 0.1 M Na₂SO₄ nondeaerated solution (Δ) and for the Pt/1 μm PPy in the 0.1 M Na₂SO₄ deaerated (○) and nondeaerated (□) solution.

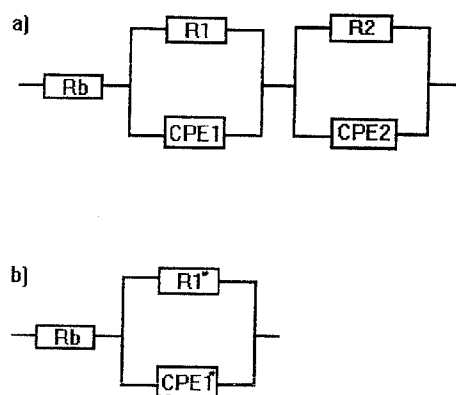

Fig. 2. Equivalent circuits for the impedance of the electrode/electrolyte interface: (a) obtained for the Pt/1 μm PPy and (b) for the Pt/3 μm PPy electrodes, both in the 0.1 M Na₂SO₄ solution.

CPE₁, R₂ and CPE₂ and the EQC for Pt/3 μm PPy included R_b, R₁* and CPE₁* connected as shown in Fig. 2.

The impedance of the constant phase element is given by the equations:

$$Z_{\text{CPE}} = (j\omega)^{-n}Q$$

and

$$1/Q = (1/R_b)^{(1-n)}C$$

where Q is a constant representative of CPE, ω is angular frequency and n is a dimensionless parameter between zero and unity which is a measure of the rotation of the impedance spectrum in the complex plane given by $90^\circ(1-n)$ and C is capacitance. The calculated total resistance of the Pt/1 μm PPy electrode, as the sum of two separate resistances R_1 and R_2 , is equal to 188 Ω cm².

The total resistance of the Pt/3 μm PPy electrode is equal to 584 Ω cm² (calculated as R_1^*). Thus, the total measured resistance of the Pt/3 μm PPy electrode is almost three times higher than the total resistance of the Pt/1 μm PPy electrode. The specific parameters are given in Table 1. It can be seen that the presence of oxygen has negligible influence on the impedance at open-circuit potential.

3.2. Cyclic voltammetry

Figure 3 represents typical voltammograms with curve (a) obtained in 0.1 M Na₂SO₄ (NAR) solution and curve (b) obtained in DAR solution, in both cases on the platinum electrode covered with 1 μm polypyrrole film. The CV curves represented in Fig. 4 were obtained on Pt covered with 3 μm polypyrrole; curves (a) and (b) were obtained in the same way as described above. The cathodic and anodic maxima were observed in NAR and DAR solutions, but as a rule, the maxima in DAR solution were lower. Therefore, it can be concluded that oxygen electroreduction takes place in the same potential range (0.0 to -0.5 V vs NHE) as reduction and oxidation of polypyrrole. The CV curve obtained on platinum in NAR solution is presented for comparison in Fig. 5. Figure 6 shows voltammograms obtained in the same solutions,

Table 1. Impedance spectroscopy characteristics of the Pt|PPy electrodes
 $S_{el} = 0.008 \text{ cm}^2$

Electrode	$R_b/\Omega \text{ cm}^2$	$R_1/\Omega \text{ cm}^2$	$R_1^*/\Omega \text{ cm}^2$	Q_1	Q_1^*	n_1	$R_2/\Omega \text{ cm}^2$	Q_2	n_2
Pt/1 μm PPy	2.18	142	—	1.53×10^{-3}	—	0.75	46	4.87×10^{-4}	0.76
Pt/3 μm PPy	2.42	—	584	—	2.25×10^{-3}	0.74	—	—	—

*The NLLS fit has been obtained using Equivalent circuit program [8]; the chi-squared values were kept below 2×10^{-5} .

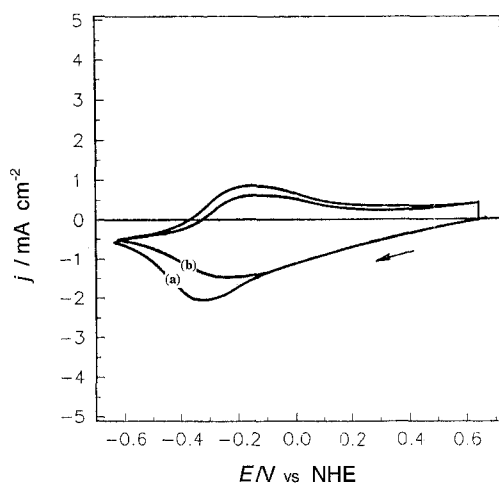

Fig. 3. Voltammograms obtained for the Pt/1 μm PPy electrode in 0.1 M Na_2SO_4 nonde-aerated (a) and de-aerated (b) solutions; sweep rate 100 mV s^{-1} .

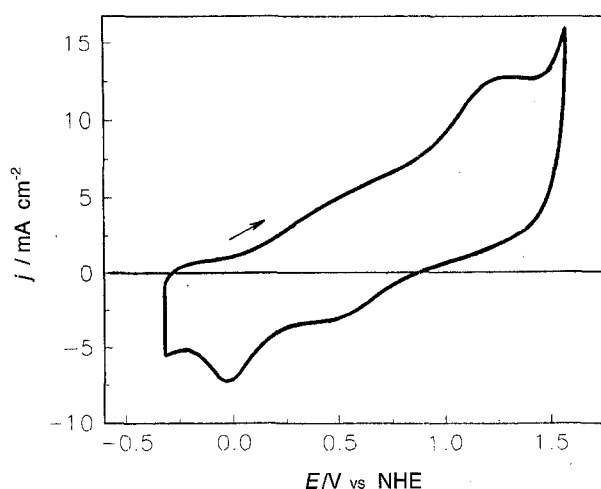

Fig. 5. Voltammogram obtained for the Pt electrode in 0.1 M Na_2SO_4 solution; sweep rate 200 mV s^{-1} .

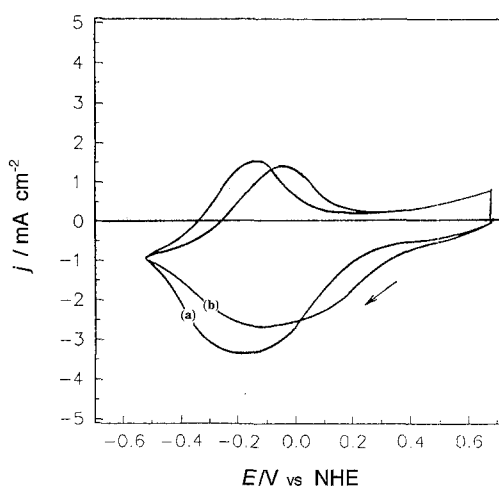

Fig. 4. Voltammograms obtained for Pt/3 μm PPy electrode in 0.1 M Na_2SO_4 nonde-aerated (a) and de-aerated (b); sweep rate 100 mV s^{-1} .

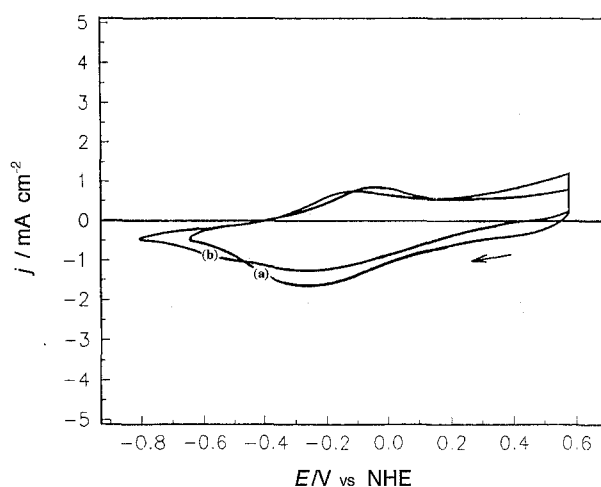

Fig. 6. Voltammograms obtained for the Ni/1 μm PPy electrode in 0.1 M Na_2SO_4 nonde-aerated (a) and de-aerated (b) solutions; sweep rate 100 mV s^{-1} .

namely NAR (a) and DAR (b), on Ni covered with $1 \mu\text{m}$ of polypyrrole. In all cases the differences between the anodic and cathodic maximum potentials are in the range 0.10–0.20 V, which is characteristic of quasi-reversible electrochemical process. According to Osaka *et al.* [9] a flat shape of the CV curve indicates that the PPy film is dense. It was assumed, that the difference between the currents at the maximum measured in DAR and NAR solutions is due to electrochemical reduction of oxygen. Comparison of all the curves (Figs 3, 4 and 6) leads to the conclusion that the rate of oxygen electroreduction is higher on platinum covered with polypyrrole than on nickel with a polypyrrole layer of the same thickness. Electroreduction of oxygen on Pt takes place at more positive potentials

(E_c) than in the case of electrodes with PPy film. This is attributable to the well known catalytic properties of Pt for oxygen electroreduction [10].

Figures 7 and 8 show polarization curves obtained on Pt/1 μm PPy and on the GC electrodes in 0.1 M Na_2SO_4 (NAR) solution and in the same solution with addition of a small amount of H_2O_2 . As can be seen electroreduction of H_2O_2 on Pt/1 μm PPy electrode begins at +0.2 V, whereas electroreduction on GC occurs at more cathodic potentials than 0.0 V vs NHE.

Comparing potential (E_c) at which oxygen electroreduction can begin on each electrode it can be stated that the reaction rate changes, depending on the

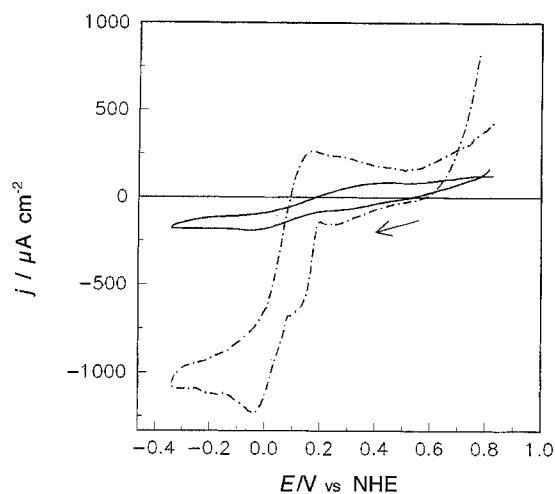

Fig. 7. Polarization curves for the Pt/1 μm PPy electrode in 0.1 M Na_2SO_4 (solid line) and in 0.1 M $\text{Na}_2\text{SO}_4 + \text{H}_2\text{O}_2$ (dot dash line); sweep rate 3 mV s^{-1} .

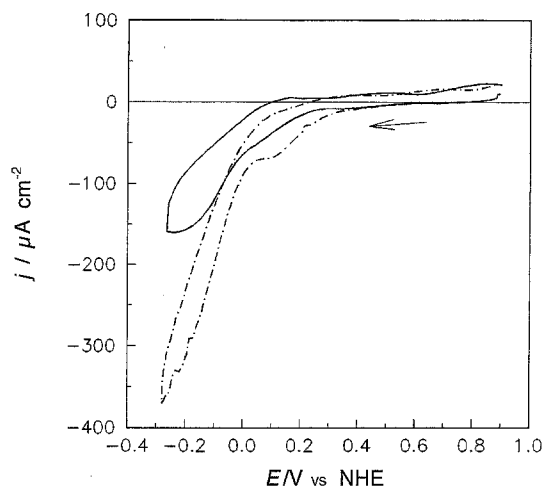

Fig. 8. Polarization curves for the GC electrode in 0.1 M Na_2SO_4 (solid line) and in 0.1 M $\text{Na}_2\text{SO}_4 + \text{H}_2\text{O}_2$ (dots dash line); sweep rate 3 mV s^{-1} .

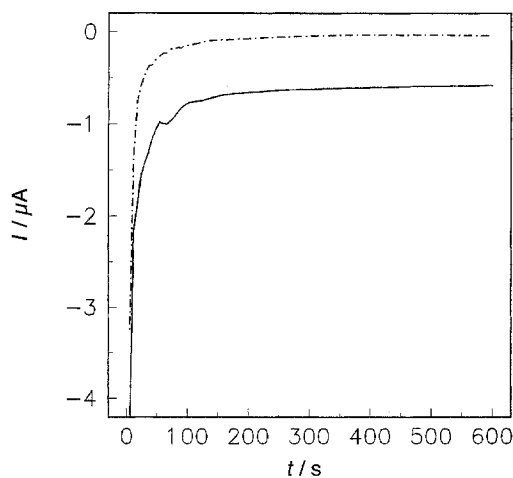

Fig. 9. Chronoamperometric curve obtained for the Pt/1 μm PPy electrode in 0.1 M Na_2SO_4 nondeaerated (solid line) and deaerated (dot dash line); $E_c = -0.05 \text{ V vs NHE}$.

Table 2. Cathodic current densities (j_c) measured at different times (t_1 and t_2) of chronoamperometric polarization
 $E_c = -0.05 \text{ V vs NHE}$

Electrode	0.1 M solution Na_2SO_4	$j_c(t_1 = 1 \text{ min})$ $/\mu\text{A cm}^{-2}$	$j_c(t_2 = 10 \text{ min})$ $/\mu\text{A cm}^{-2}$
Pt/1 μm PPy	deaerated	-24	-4
	nondeaerated	-100	-58
Ni/1 μm PPy	deaerated	-16	-3
	nondeaerated	-41	-15
Pt/3 μm PPy	deaerated	-41	-4
	nondeaerated	-100	-5

electrode material, in the order: Pt > Pt/1 μm PPy > Ni/1 μm PPy > GC. A comparison of the cathodic current densities (j_c) may be misleading, since the real and geometric surface areas of the Pt, GC and Pt/1 μm PPy electrodes differ significantly.

3.3. Chronoamperometry

Figure 9 shows typical CA curves obtained at -0.05 V , (the complete description is given below the figure). It can be seen, at the beginning of polarization, that j_c decreases rapidly before reaching a stable value at the plateau. Table 2 shows the measured values of j_c after 1 and 10 min of cathodic polarization. It was found that j_c for oxygen electroreduction in the case of Pt/3 μm PPy declined to values 10 times smaller than in the case of Pt/1 μm PPy. The cathodic current densities measured at the plateau also depend on the base material on which polypyrrole was deposited. This suggests that the electrode reaction takes place not only on the polymer/electrolyte interface but also on the metal-polymer boundary, (or metal/solution in the pores of the PPy film). This is in agreement with observations of other authors investigating oxygen electroreduction in acidic solutions [1].

3.4. Electrolysis

The oxygen electroreduction process is very complicated [10]. However it can be presented in a simple

Table 3. Changes of catholyte pH during the cathodic polarization, ($E_c = -0.05 \text{ V vs NHE}$, $t_c = 10 \text{ min}$) on Pt electrode ($S_{el} = 2.4 \text{ cm}^2$) covered with polypyrrole layer of various thickness

Thickness of PPy layer/ μm	Q_t $/\text{mC}$	pH_1	pH_2	ΔpH $\text{pH}_2 - \text{pH}_1$	$Q(\text{OH}^-)$ $/\text{mC}$
0.3	312.5	6.09	9.74	3.65	132.7
1.0	396.3	6.08	10.16	4.08	349.0
2.0	229.6	6.42	9.06	2.64	27.7
3.0	129.0	6.13	7.34	1.21	0.5
5.0	130.5	6.72	6.72	0.00	0.0

Q_t : total charge passed during cathodic polarization.
 $Q(\text{OH}^-)$: calculated charge used for OH^- formation.
 pH_1 : pH of the solution before polarization.
 pH_2 : pH of the catholyte after polarization.

Table 4. Changes of catholyte pH and the quantity of H_2O_2 produced during cathodic polarization, ($E_c = -0.05 V$ vs NHE, $t_c = 10$ min), as a function of the electrode material

Electrode	$Q_t^*/mC\text{cm}^{-2}$	pH_1	pH_2	$\Delta pH/cm^{-2}$	$Q^*(OH^-)/mC\text{cm}^{-2}$	$c(H_2O_2)/g\text{dm}^{-3}$	$Q^*(H_2O_2)/mC\text{cm}^{-2}$
Pt	125.5	6.39	9.87	1.45	74.6	0.33×10^{-3}	9.7
Pt/1 μm PPy	149.9	6.43	10.13	1.58	135.7	0.44×10^{-3}	13.0
GC	36.3	6.43	6.49	0.03	0.03	0.88×10^{-3}	31.8
GC/1 μm PPy	115.1	6.47	9.18	1.38	18.6	0.77×10^{-3}	27.9
Steel/1 μm PPy	91.6	6.08	9.28	1.07	15.3	0.66×10^{-3}	15.6
Ni/1 μm PPy	84.6	6.27	9.76	0.87	34.7	0.44×10^{-3}	7.8

* The geometric surface area has been taken in to account to calculate all electrode charge densities and pH.

Q_t : total charge density passed during cathodic polarization.

$Q(OH^-)$: calculated charge density used for OH^- formation.

$Q(H_2O_2)$: calculated charge density used for H_2O_2 formation.

$c(H_2O_2)$: the concentration of H_2O_2 in the solution after cathodic polarization.

pH_1 : pH of the solution before polarization.

pH_2 : pH of the catholyte after polarization.

schematic form:

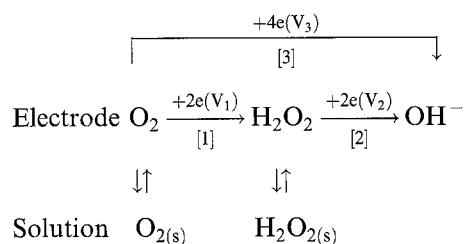

As can be seen the final product (OH^-) can be obtained as the result of the parallel paths (1 and 2 or 3). If the process proceeds in accordance with reactions 1 and 2 then H_2O_2 is an intermediate product and its further reduction may determine the rate of the whole electrode process. Thus, the pH and the concentration of H_2O_2 in the catholyte after electrolysis may be taken as a measure of the rate and cathodic efficiency of the oxygen reduction on the cathode.

Table 3 represents the changes in catholyte pH given as a result of the electroreduction of oxygen on platinum and on platinum covered with polypyrrole film of various thicknesses. Assuming that the pH change after a given polarization time is a measure of the rate of oxygen electroreduction, the reaction rate significantly decreases when the film thickness exceeds 1 μm . The highest efficiency, calculated as a ratio $Q(OH^-)/Q_t$ (see Tables 3 and 4) was obtained for Pt/1 μm PPy. In Table 4 catholyte pH changes and H_2O_2 contents are given as a result of polarization of electrodes covered with a 1 μm thick PPy film at $E_c = -0.05 V$. The efficiency and rate of the electroreduction process apparently depends on the nature of the base electrode (Pt, Ni, GC and steel). As mentioned above, the rate of cathodic reaction decreases in the following order: Pt/1 μm PPy, GC/1 μm PPy, Ni/1 μm PPy and steel/1 μm PPy. The low concentrations of H_2O_2 after electrolysis on platinum and nickel covered by the PPy film electrodes indicates that the reduction of oxygen on these electrodes mainly follows path 3 (involving four electrons). This is very useful, because the PPy film is not stable in the presence of H_2O_2 . However, if steel and GC

electrodes covered by PPy film were used, participation of the 2 and 4 electron reactions are comparable. Thus, it can be concluded that the Ni/1 μm PPy electrode appears to be the most effective electrode material for dioxygen removal from neutral solutions.

4. Conclusions

The following points can now be made:

- (i) Oxygen electroreduction on a polypyrrole electrode proceeds at a significantly higher rate than on a glassy carbon electrode.
- (ii) The results obtained indicate that a nickel electrode covered with a polypyrrole film may be employed for the removal of oxygen from water to decrease its corrosivity.
- (iii) Investigations of the effect of the thickness of PPy film on the oxygen electroreduction rate in 0.1 M Na_2SO_4 solution have shown that 1 μm film is the optimum thickness.

Acknowledgement

Authors are grateful fo the Polish Research Committee for the financial support, grant no. KBN 956082/00.

References

- [1] R. C. M. Jakobs, L. J. J. Janssen and E. Barendrecht, *Electrochim. Acta* **30** (1985) 1433.
- [2] F. T. A. Vork, L. J. J. Janssen and E. Barendrecht, *ibid.* **31** (1986) 1569.
- [3] F. T. A. Vork and E. Barendrecht, *ibid.* **35** (1990) 135.
- [4] K. Vourilehto, S. Ylassari and O. Forsen, Proceedings of the 12th Scandinavian Corrosion Congress, Vol. II, Espoo, Finland (1992), p. 673.
- [5] K. Vourilehto, A. Tamminen and S. Ylassari, *J. Appl. Electrochem.* **25** (1995) 973.
- [6] B. Flintjer and W. Jansen, *PdN-Ch* **3/38**, Jg. (1989) 7.
- [7] F. Aziz and G. A. Mirza, *Talanta* **11** (1964) 889.
- [8] B. A. Boukamp, *Solid State Ionics* **11** (1984) 39.
- [9] T. Osaka, T. Momma, K. Nishimura, S. Quaked and T. Ishii, *J. Electrochem. Soc.* **141** (1994) 1994.
- [10] A. J. Bard, 'Encyclopedia of Electrochemistry of the elements', Vol. 2, Marcel Dekker, New York (1974).